

Article number: 439600360

Description: Rota-fix shaft-hub connection FS360x455

Note: Self centering - very high torque.

## Measures

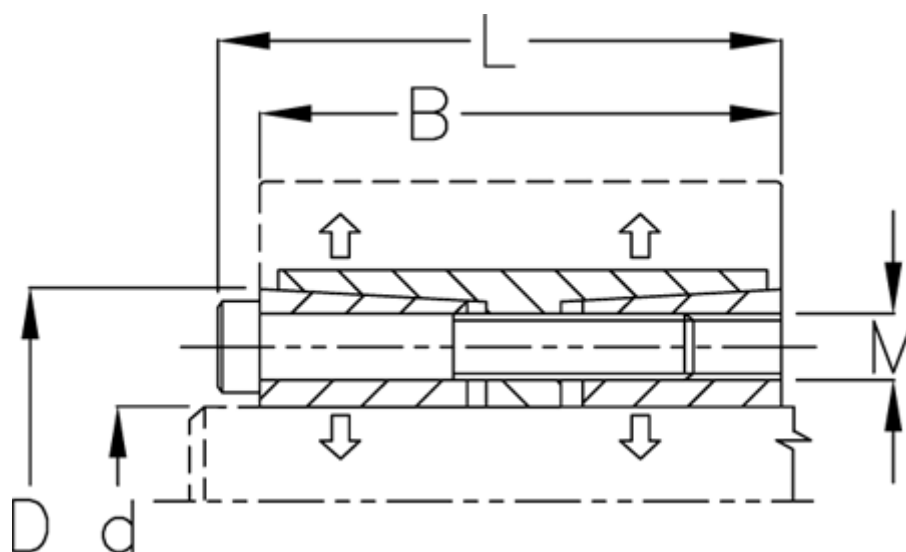

B mm	= 155
d H8 mm	= 360
D mm	= 455
Fit tolerance	= Aksel h8, Nav H8
F kN torque	= 2783.0
L mm	= 177
M mm	= M22
P N/mm <sup>2</sup> surface pressure on shaft/hub	= 142

Surface roughness	= R? ? 3.2 $\mu$ m
T N m torque	= 501000
Ts N m bolt tightening torque	= 930.0